

# Diffuser Specialist

## Asymmetric Lenses Model T-10

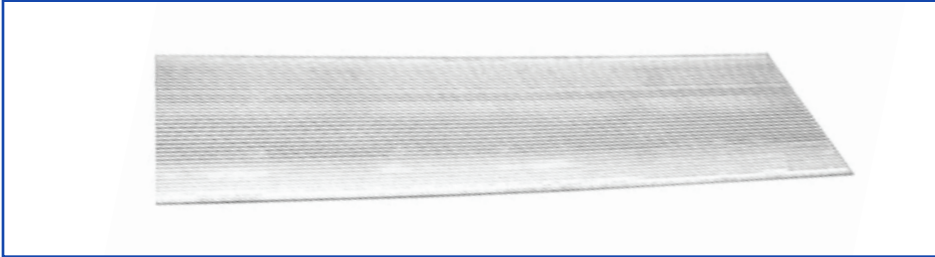
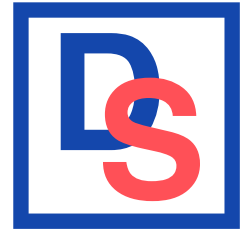

### General Description

T-10 Lenses can be assembled in recessed or surface mounted luminaires. The geometric designs of linear axis prisms control the source light to deliver an asymmetrical lighting distribution from 1 Lite and 4 Lite fixtures.

### Application

T-10 Lenses are suitable for commercial, institutional, hospital, retail and residential lighting applications. A conductive grid which shields electromagnetic interference (EMI/RFI) and complies with the requirements of MIL-STD-461 (E) can be supplied on these Asymmetric T-10 lenses.

Typical beam distributions are found on the back page. The photometric data shows 29 footcandles are achieved from the 2377 candela directly below the four lamp fixture.

### Ordering Information

Please call 1.800.880.5483 for price and delivery.

Specify lens size when placing an order. Custom widths and lengths are available. Typical lead time is four to six weeks.

### Notice

Diffuser Specialist assumes no responsibility for suitability of luminaires and applications. The use of lenses near and above 70°C temperatures with high UV output light sources will cause degradation of the material.

### Model T-10

1 Lite

4 Lite

### Widths:

12" and 23-3/4"

### Lengths:

47-3/4" and 48"

Lenses for commercial, institutional, hospital, retail and residential applications

### Standard Material:

Fluorescent grade acrylic with shielding available

Please inquire for further material options

# Diffuser Specialist

## Asymmetric Lenses Model T-10

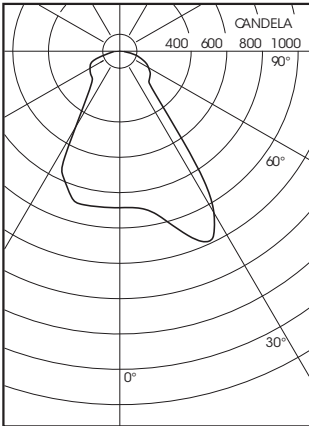
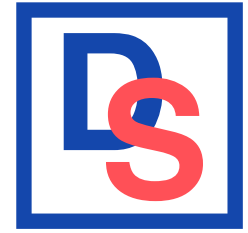

Report No.: LL02527  
Single 32 watt T8 Fluorescent  
12 inch Asymmetric Lens in white painted troffer

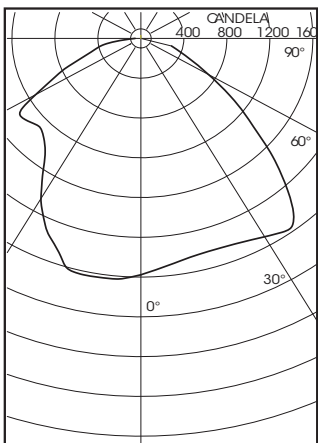

Report No.: LL02504  
Four 32 watt T8 fluorescent lamps  
24 inch Asymmetric Lens in white painted troffer

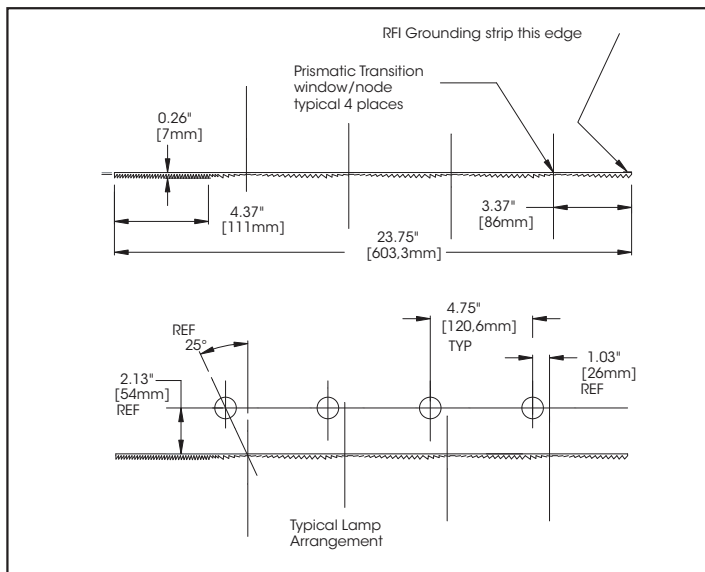
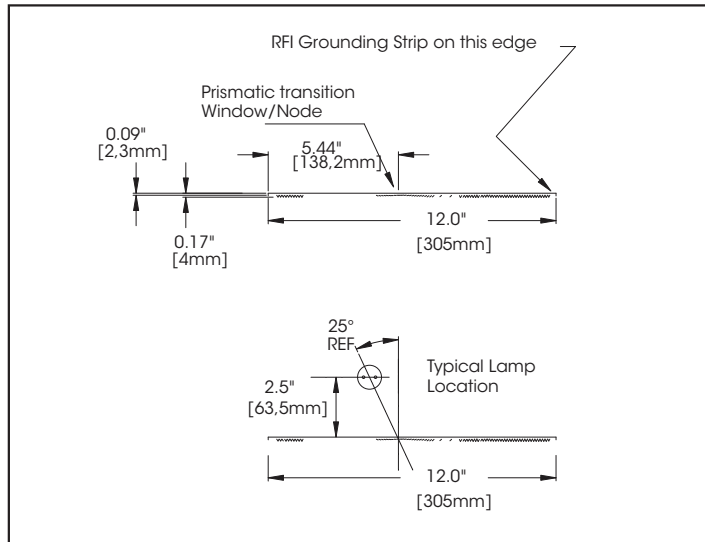

This drawing is for reference only. Actual part dimensions will vary. Customer is urged to review actual samples to confirm fit and function. All specifications and dimensions are subject to change without notice.